

OPERATING MANUAL

Tech. Doc. No. 509

Pneumatic Chain saws

5 1020 0020

5 1021 0020

5 1022 0020

5 1023 0020

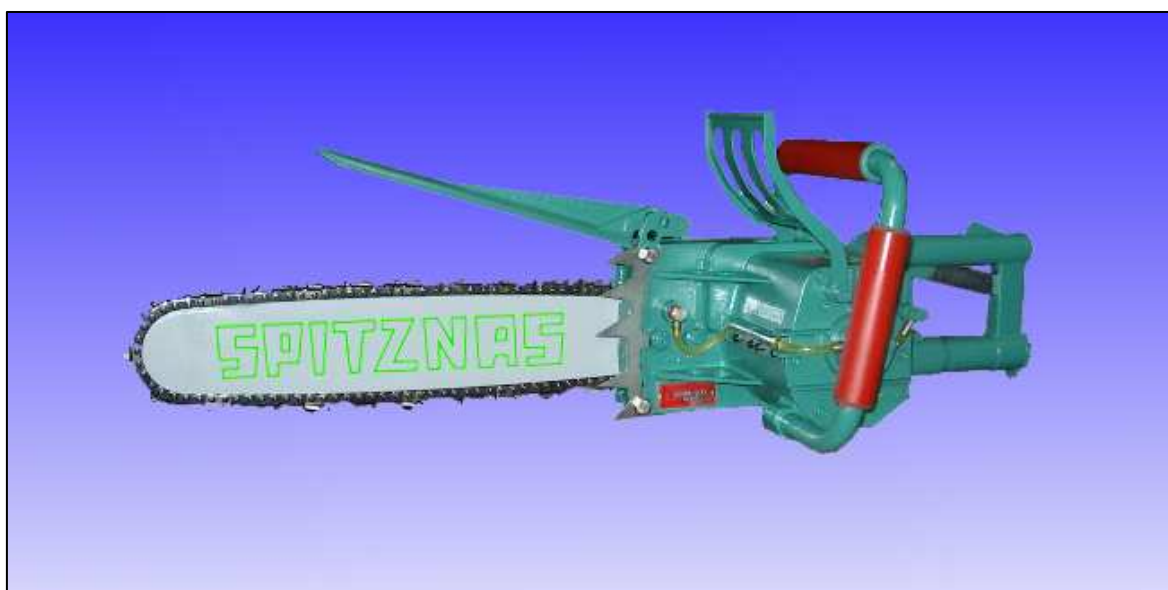

INDEX	Page
Safety Instructions	3 - 9
Maintenance and Repairs	10
Assembly of bar and chain	10
Disengaging the chain-brake	11
Tensioning the chain	12
Checking the tension of the chain	12
Filling the chain lubricating oil	13
Checking the chain lubrication	14
Chain-brake	14
Blocking of the chain with the chain-brake	14
Disengaging the chain-brake	15
Controlling the function of the chain-brake	15
Maintaining the chain-brake	16
Keeping the bar proper	16
During the first period of operation	16
During the operation	16
After the operation	17
Sharpening the chain	18
Lowering the depth limiter	18
General filing instructions	18
Chain repair	19
Shortening and lengthening of the chain	19
Replacing of broken drive links	20
Installation of new parts	20
Chain bar	21
Sprocket	22
Maintaining the chain clean and sharpened	23
Maintenance schedule	25
Storing the saw	25
Procuring spare parts	25
Technical specification	26

FOR YOUR SAFETY

Special safety measures are necessary at working with the chain saw.
Working with it is a lot faster than with an axe or hand saw and because you are working with a high speed chain.



Read carefully the whole operating instructions before you start work.
Not observing the safety instructions can be life-menacing.

Observe the accident prevention regulations of the employers' liability insurance association

Who is working with such a saw for the first time should be instructed by the seller how to handle it or should take part at a special course of instruction.

Minors are not allowed to work with such a saw except for juvenils over the age of 16, who get trained under a supervision.

Keep children, animals and viewers away!

The user is reported for accidents or risks, that can be against other people or their property!
Do only give the motor saw to people who know the model and its handling and do always give them the operating instructions.

Who is working with a motor saw has to be fit

- awake, healthy and in good shape
- has to lodge working breaks in good time
- you are not allowed to work with such a saw while you are under the influence of medication, alcohol, or other drugs, because that can effect the reaction.

With hear protecting that has been put on, you have to be attentive and careful, because the recognizing of dangerous sounds (screaming, signal sounds, etc.) is disturbed.

Do not work alone

You have to keep a position where other people can hear you if an accident happens and you start screaming.

Do only use attachments, which have been delivered by SPITZNAS or have been explicitly released for the attaching!

Other attachments are not allowed to be used, because they could lead to bigger dangers. SPITZNAS takes out any liability for person- and property damage, in which use of not approved attachments has occurred.

FOR YOUR SAFETY

Do wear provisioning clothing and outwear!



The clothing has to be purposing and shall not hinder.
Wear tight clothes with insert-combined suit, no working suit!

There should be no clothing, no scarf, no tie, no jewells – that can possibly get into wood or undergrowth. Take care of long hair (hair-net)!



Wear safety boots with maximal grip and steel cap!



Use a hard hat if parts could fall down!
Do also use goggles!

Use „personal“ hear protection! Like ear-flaps.



Wear tight and non-slip gloves!
Made of chromium leather

Transporting the motor saw

Only if the air supply is separated.
Always attach chain guard – even for transport over a short distance.

Carry the saw only at the pipe handle

Guide (bar) should face to the back!

Transporting in vehicles:

Protect the saw so that it cannot fall to the side and get damaged. If the motor saw is not in use it should be put to the side so that there is no risk for anybody.

FOR YOUR SAFETY

Before you start the saw

Check if the saw is in safe condition. Observe the corresponding chapter in the operating manual.

- chain-break must be in proper condition
- the guide (bar) has to be fixed well
- chain has to be tensioned the right way
- valve lever and valve lever latch have to be fingertip easy.
Valve lever has to spring back into the neutral position by itself.
- Do not make changes concerning the operating and safety equipment!
- Keep the handles clean and dry from resin – for the safe guiding of the motor saw!

The motor saw should only be used in totally safe condition (Danger of accident)

Starting the motor saw

The motor saw is only used by one person. Do not keep other people in the working area!

FOR YOUR SAFETY

Do always hold the saw tight in both of your hands for the right guiding.

The right hand is holding the back handle (even left-hander) pipe handle and handle should be hold tight with the thumb.



Make sure that you are standing very solidly.

Put the saw under full power into the cut and place the claw-type stop fixed - only than start to cut

Defend dangers in general

When you have put on the hear protecting you need to be very attentive and careful because you cannot recognize dangers soon enough (sounds like screams, signals etc.) If there is a danger, immediately switch off the motor.

Do not put a leg or an arm into the enlarged sawing range of the chain.

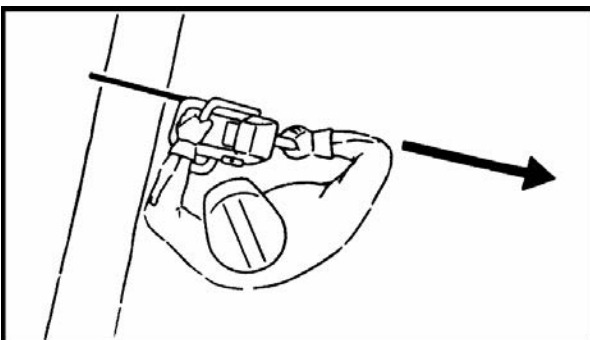

Pull the saw out of wood only if the chain is still working.

Never work without a stop. The saw can possibly pull the worker to the front.

Work attentively and quietly and only with good light and clear sight.

Do not get others in danger. Attentive working is important.

FOR YOUR SAFETY

Use a guide which is as short as possible:

Chain, guide and sprocket have to fit to each other and also to the motor saw!

Be careful slippery, when wet, slipperiness, snow, ice on slopes or uneven offroad, on fresh peeled wood (bark).

When you work in higher altitude, a lift working platform should always be used.

Never work on a ladder -

Never in unsolid places -

Never above shoulder level -

Never with only one hand!

Motor saw shall only be used for cutting, not for lifting up or scooping away cut-off pieces.

Only wood or wooden things shall be cut.

Do not let foreign substances touch the saw. Stones, nails can sling away and can damage the chain and the motor saw can possibly bound up!

At the slope do always stand at the top or the right next to the log or to the laying tree.



Take care of the down-rolling logs.

Danger of stumbling.

You can fall over roots, stumps of trees or ditches.

Be careful when you cut spilling wood. There is a danger of injuring with spilling pieces of wood.

FOR YOUR SAFETY



Danger because of kickback!
Kickback can lead to deadly cutting injury!

If a kickback happens the saw suddenly can sling towards the user, e.g.

- if the chain hits unintentionally wood or a hard object in the area around the upper quarter of the bar nose.
- if the chain on the bar nose gets stuck in the cut.



Reducing danger of kickback

- Hold the saw tightly with both hands and sure grip
- Do only cut with full power
- Do always watch the bar nose
- Do not cut with the bar nose
- Do not bend forward so far
- Do not cut above shoulder level
- Do only put the bar very carefully in the cut
- Do only „plunge“ if you are familiar with that working procedure
- Pay attention to the position of the trunk and to the forces which close the cutting slot and can jum the chain
- Do only work with a right sharpened and tensioned chain. The clearance of the depth limiter should not be too large.

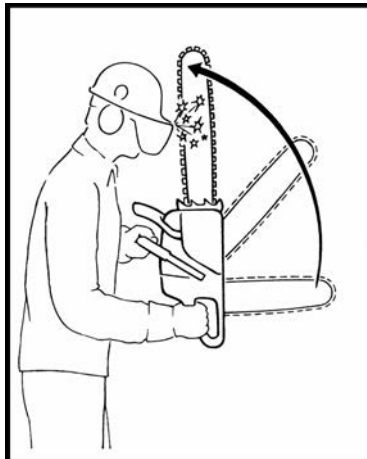
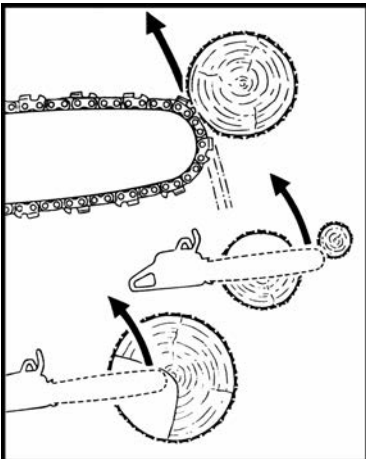

FOR YOUR SAFETY

Decreasing the danger of accidents

Quick-stop chain-brake:

With this the danger of injuring can be reduced in certain situations but the kickback itself can not be avoided. When releasing the chain-break the chain comes to standstill in a split second as described in paragraph „Chain-break“ in the operating manual.

Cutting set:

Kickback arms, right sharpened chains as well as a bar with a little barhead decrease danger of kickback.

It is a lot safer to decrease kickback with clever and right work.

Avoid drawing in and rebound!

A = To draw in

If at the cutting with the subside of the bar (forehand-cut) the chain jums or touches a tough object in the wood, the motor saw can be abruptly pulled towards to the trunk.

The claw-type stop shall always be fixed safely!

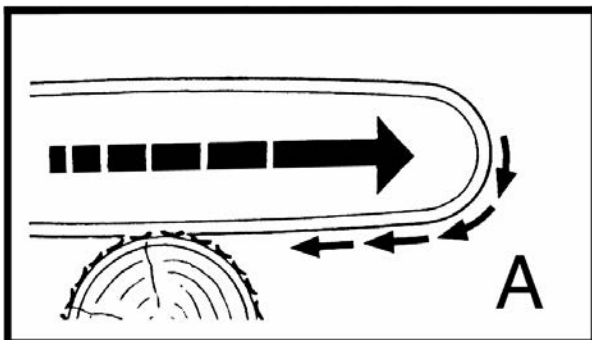

B = Rebound

The motor saw can be pushed back towards the operator, if during cutting with the upper side of the bar (backhand-cut) the chain touches a tough object in the wood.

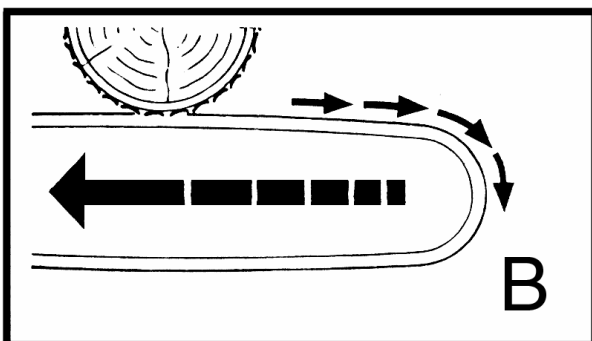

MAINTENANCE AND REPAIRS

Maintain the saw regularly. Make only maintenance and repairs that has been described in the Operating Manual.

Let other work be done by SPITZNAS-after-sales service. Only original SPITZNAS spare parts should be used.

Do not change anything at the motor saw. The safety could be endangered.

Separate from air supply

- for checking tension of chain
- for tensioning the chain
- for changing the chain
- for clearing a fault

Check the chain catcher

replace it if damaged

Pay attention to sharpening instructions

for right handling of chain and bar. Keep chain in a perfect shape, right sharpened and tensioned and lubricated.

Replace chain, guide and sprocket in due time.

Keep motor and chain lubricating oil only in labelled containers according to regulations.

ATTENTION!

If trouble of function of the chain-break occurs shut down the motor saw immediately – danger of injury!

Look for SPITZNAS-after sales service!

Do not use the motor saw until this problem is not solved (Look chapter „Chain-brake“).

Assembling of bar and chain

Pitch of the chain has to be adjusted to spacing of the sprocket and the bar and thickness of drive link has to be adjusted to the width of the groove of the bar.

Turn-off nuts and remove cover

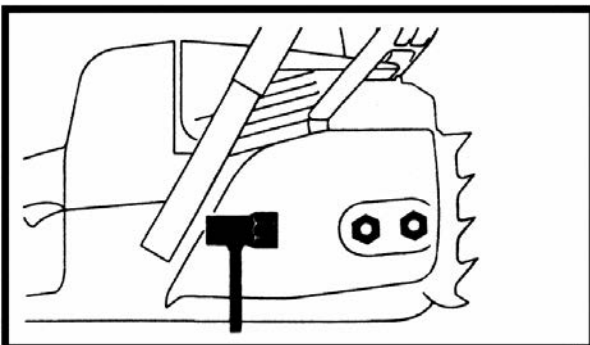

MAINTENANCE AND REPAIRS

Turn screw (1) to the left until clamp nut (2) lies close to the left of housing recess.

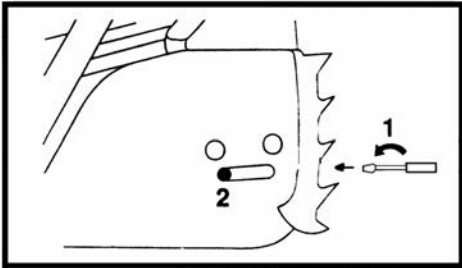

Loosening the chain-brake:

Press hand protection (3) against the pipe handle.

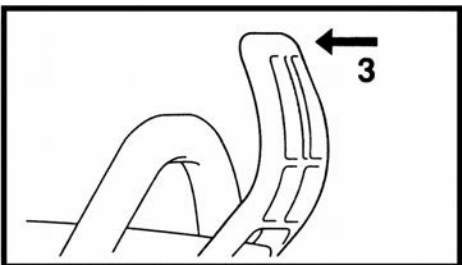

Pull on protecting gloves
Put on the chain (starting at the bar nose).

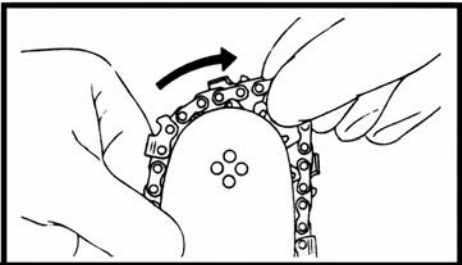

Put the guide bar over the screws (4). (The cutting edges have to face to the right) and put the fixing bore (5) over the pin of the clamp nut. At the same time put the chain over the sprocket (6). Turn adjusting screw (7) to the right, until the chain still hangs out a little bit and the noses of drive links are put into bar groove.

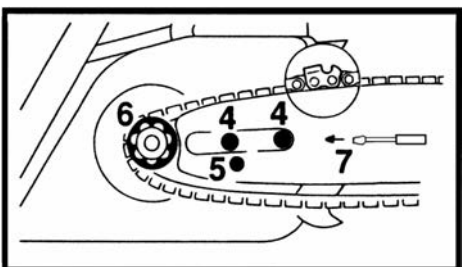

Attach the cover back and tighten the nuts lightly by hand.
After this adjust tension of chain. (Segment „Adjust tension of chain“)

MAINTENANCE AND REPAIRS

Adjust tension of chain

during operation:

Stop motor and disconnect it from air supply. Only then loosen the nuts (1)!

Lift bar nose and screw clamp nut (1) with a screwdriver to the right until the chain lies at the underside of the bar. Go on lifting up the bar and tighten the nuts (1) very strong.

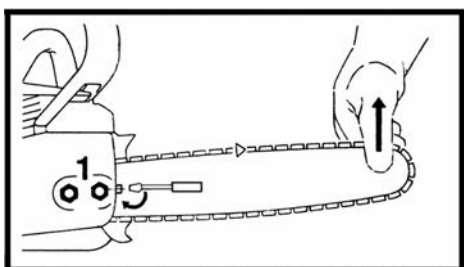

Check chain tension

Stop the motor.

Put on protecting gloves!

The chain has to lie at the underside of the bar and it has to be pulled with loosened chain-brake by hand.

If necessary, adjust tension.

A new chain has to be adjusted oftener than a chain which is already for a longer period in use.

Check chain tension more often – segment „During the operation“!

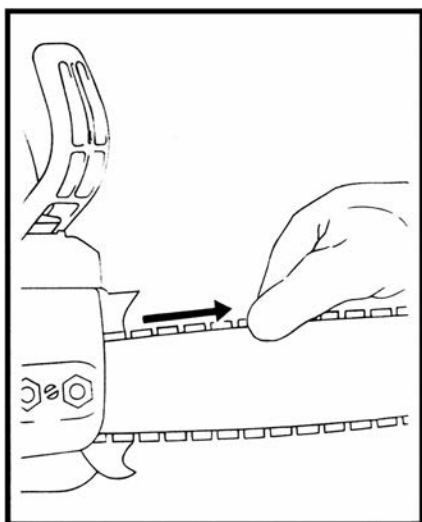

MAINTENANCE AND REPAIRS

Service life and performance of the chain saw are determined by

- a) Degree of air purity
- b) Lubrication and maintenance

To a) Blow the air hose clear before connecting it to the saw. Install dirt and water separators upstream of the saw, if it is not possible to prevent the formation of rust and water condensation in the air distribution lines.

To b) The motor is lubricated by the lubricator installed in the handle. Fill the lubricator with resin- and acid-free SAE 5W – SAE 10W lubricating oil. Thick flowing oil will clog the vanes and affect the start-up and performance of the motor. Only proper maintenance can ensure constant performance, reduction in wear and thus, a decrease in operating costs and an increase in service life.

We therefore highly recommend to install service units upstream of the machine.

Observe the comments in the information sheet

„MAINTENANCE OF PNEUMATIC TOOLS“

Enclosed greased ball bearings must not be flushed.

After use, clean the saw and rinse it with light oil or provide alternate corrosion protection.

Regularly check and clean the air inlet screen.

In winter, or when using very moist air, an antifreeze lubricant, such as BP Energol AX 10, Kilfrost or Kompranol should be used.

Replace wear parts – in particular the vanes – when necessary.

Vanes are considered worn if their width is less than 16 mm.

Lubricating of the chain works through the second lubricating system with automatic line oil pump. The oil tank (250 ccm) is located in the motor housing and has to be filled with chain saw oil before starting. It contains oil for approx. two working hours. Check transparent oil line, if oil is conveyed to the chain or hold running saw with the bar pointing downwards and if adjustment is correct, an oil trace will be clearly observed on a light coloured floor or paper.

Use machine oil with adhesive additive of a viscosity of 49-55 c ST (6,5 – 7,5 E) at 50°C (122 F). Replace valves of the oil pump, if they are no more leakproof. Before assembling the valve should be dipped into oil. Pay attention to the right sequence of the valves (ball and feather should lay next to both valves at the left).

Filling in chain lubricating oil



- Clean the tank screw-cap and the area around, so that the tank cannot get dirty.
- Fill in chain lubricating oil.

MAINTENANCE AND REPAIRS

If the flow in the oil tank does not change lubricating oil delivery can be interrupted. Check chain lubrication. Clean the oil passages. Possibly look for the SPITZNAS after-sales service.

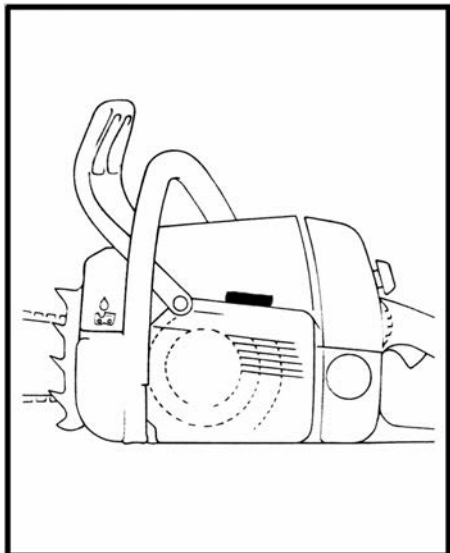

Checking the chain lubrication

The chain always has to sling off a little oil.

- Never work without chain lubrication! If the chain is working dryly the cutting set can be destroyed in short time. Before starting the work always check chain lubrication and the oil level in the tank.
- Every new chain needs a run-in period time of 2 to 3 minutes.

After running in check chain tension and adjust it if necessary. Segment „Checking chain tension“!

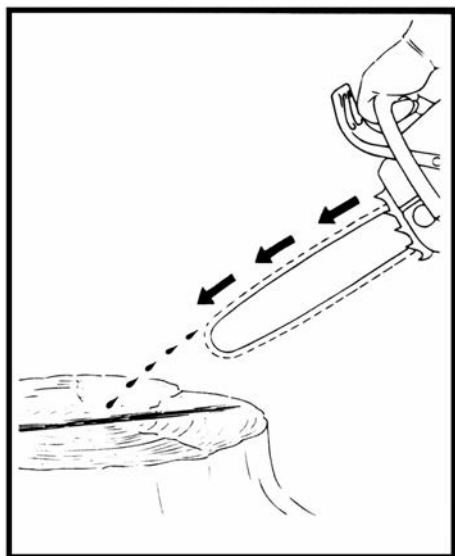

MAINTENANCE AND REPAIRS

Chain-brake

Blocking the chain with the chain-brake

- when emergency

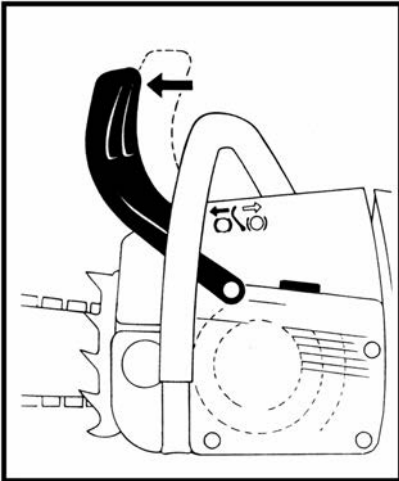

Hand guard to the bar nose - with the left hand - or automatically - by the kickback:
the chain get blocked and stops

Releasing the chain-brake

- Pull the hand guard to the pipe handle.

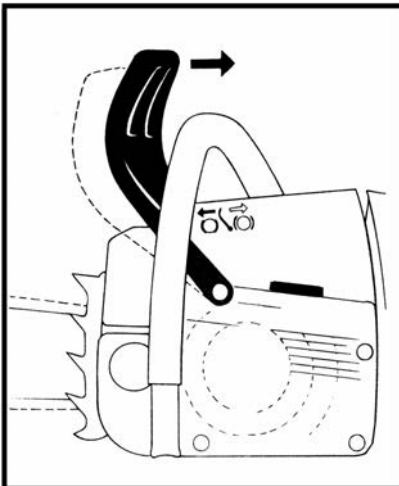

Tip: Before opening the handle valve (except for the function control) and before cutting the chain-brake has to be released.

The chain-brake works only, if no change will be made on the hand guard.

Controlling of function of chain-brake

Every time before starting work: block the chain (hand guard against nose of the bar and open the valve of the handle for a short time (max. 3 sec.) The chain should not run also. The hand guard has to be clean and light moveable.

MAINTENANCE AND REPAIRS

Maintenance of chain-brake

The chain-brake is subjected to normal wear. For serving a good performance, it has to be maintained by well trained personnel (e.g. after-sale-service) at regular intervals:

Professional fulltime work	every three months
Half-professional (Agriculture & Construction)	twice a year
Hobby and free-time user	once a year

Keeping the bar proper

Turn over the bar after every sharpening of the chain or replacing the chain to avoid wear out on one side only especially at the return steering and the underside.

Clean regularly

- 1 = Oil inlet hole
- 2 = Oil outlet port
- 3 = Bar groove

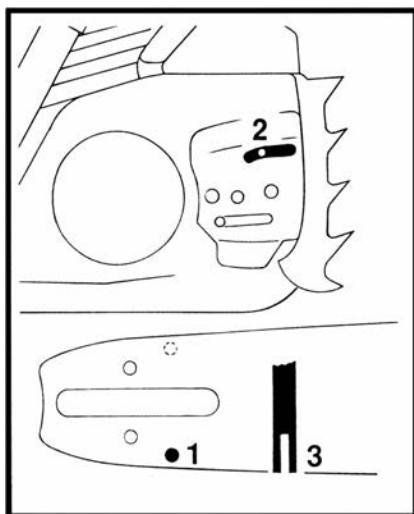

During the first period of operation

Always pay attention to: Opening of valve only with released chain-brake. Opening of valve at blocked chain-brake (chain is stalled) causes in a short time to damages on the chain drive (chain-brake).

During the operation

Check tension of chain more often!

A new chain has to be adjusted more often than one that is in use for longer!

MAINTENANCE AND REPAIRS

In cold state:

The chain must lean against the bottom side of the bar but it has to be still pulled around the bar by hand. If necessary, adjust tension of the chain again. Paragraph „Tensioning the chain“!

With operating temperature:

The chain stretches and slacks. The drive links at the bottom side of the bar shall not come out of the groove. Otherwise the chain can spring out. Adjust tension of the chain, paragraph „Tensioning the chain“!

After work it is important to relieve tension! During cooling the chain shrinks. A chain which is not relieved from tension can possibly damage the rotor shaft and the bearing.

After operation

- Relieve tension of chain, if it was tensioned during work at operation temperature.

Chain shrinks during cooling. A chain which is not relieved from tension can possibly damage the bearings.

A longer shut down of the machine –

- Look at Chapter „Storing the saw“

MAINTENANCE AND REPAIRS

Sharpening the Chain

Lowering the depth limiter

1. When sharpening your chain with a file holder, the clearance of the depth limiter must be checked and adjusted if necessary after sharpening.
2. Check the clearance of the depth limit at least after every third sharpening, and after every sharpening when cutting frozen wood.
3. Place depth limiter gauge on cutting tooth. If depth limiter is too high, file off protruding part with as flat file (Fig. 1)
4. Round off front edge of depth limiter. Its original shape must be preserved (Fig. 2).

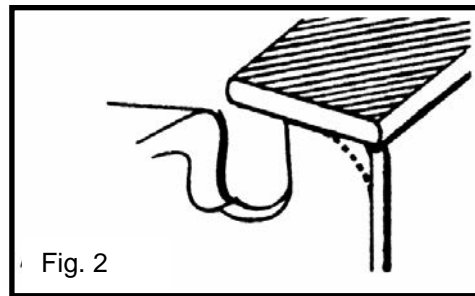
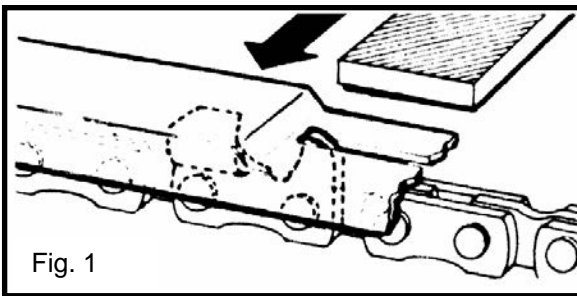

General Filing Instructions

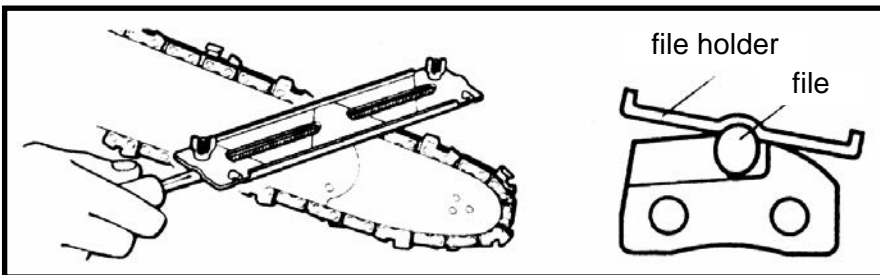

1. Place file holder on top of tooth and depth limiter.

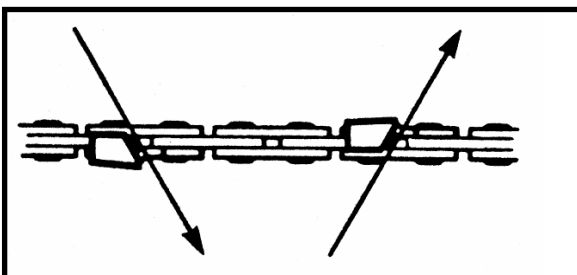

2. First file all cutting teeth on one side using an outward cutting stroke. Then file the cutting teeth on the other side.

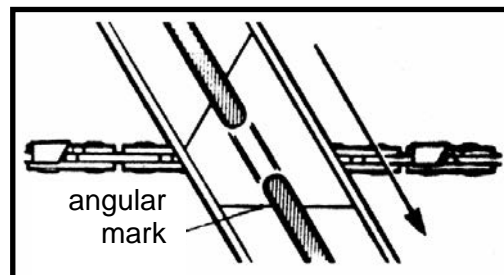

3. Keep marks on file holder parallel to chain.

MAINTENANCE AND REPAIRS

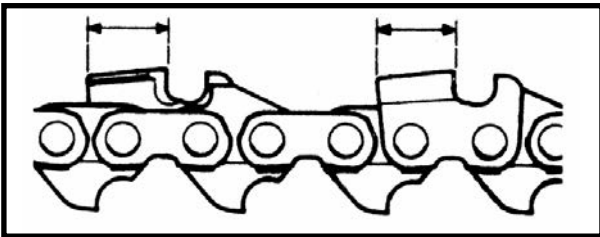

4. All cutting teeth must be of equal length.

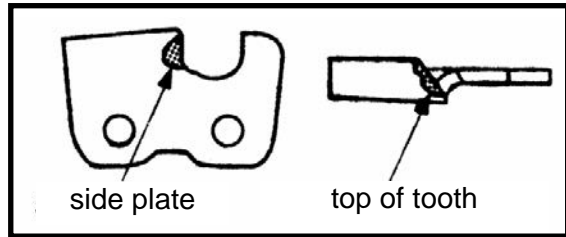

5. Always completely file away any damage areas on side plate and top of tooth.

The chain supplied with the saw is to be sharpened at the following angles.

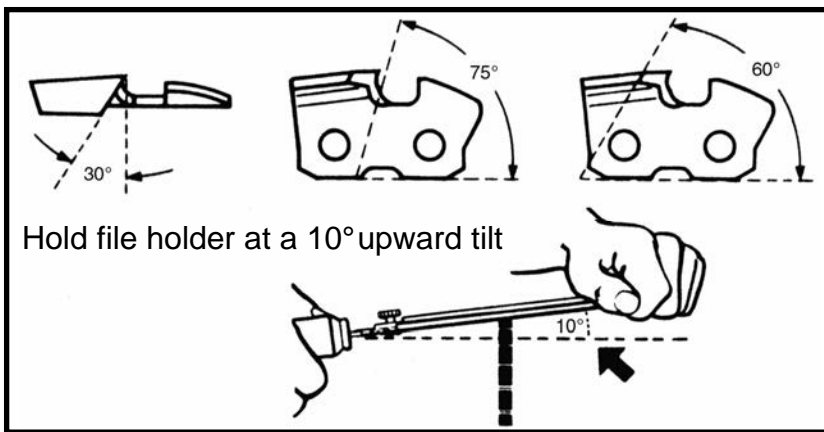

Chain Repair

Shortening and lengthening the chain

(Chain added between two left-hand cutting teeth)

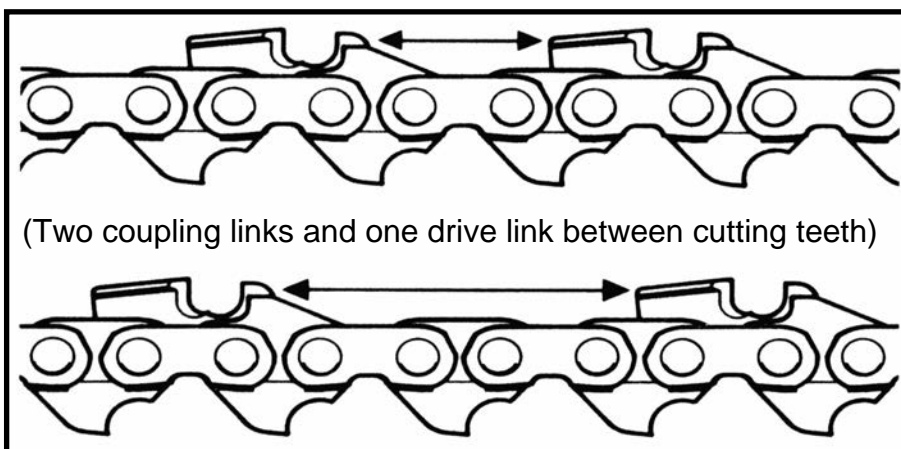

Most chain saws are assembled with one coupling links between a right-hand and a left-hand cutting tooth, however there are also chains which are assembled differently due to their length (number of drive links). If a chain must be shortened or lengthened, it is best to do so at this point. However do not insert more than two coupling links between two cutting teeth.

MAINTENANCE AND REPAIRS

IMPORTANT: When shortening the chain, always remove the standard drive link and not the safety drive link.

Replacing broken drive links (Grind off rivet heads if necessary)

Lay chain in the corresponding recess of the anvil with the cutting tooth always pointing upward. Press out rivets.

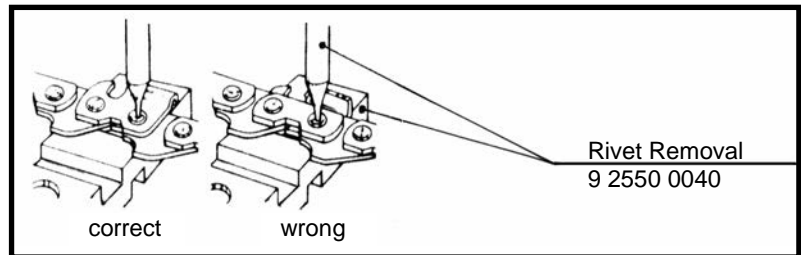

Installation of new parts

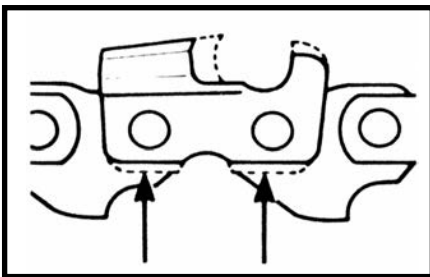

1. File the running surface of new chain links so that they are the same as those of the worn links. File back new cutting teeth so that they correspond to the worn ones.

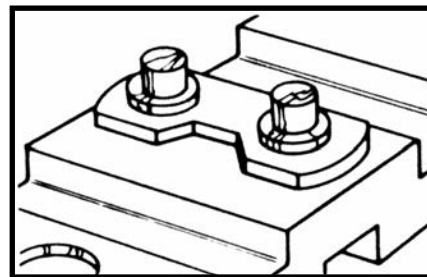

2. Place coupling link with rivets on a flat surface.

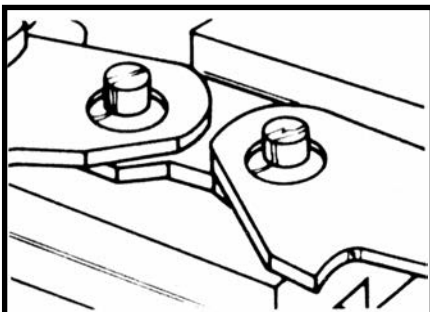

3. Join ends of chain

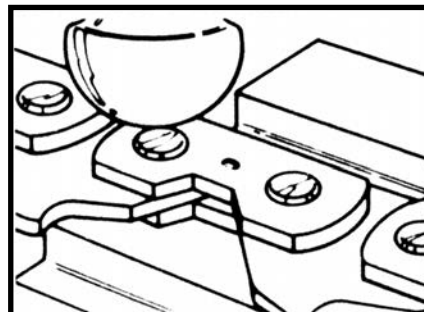

4. Place side plate of coupling link with mark facing up. Flatten rivet heads with ball end of hammer.

MAINTENANCE AND REPAIRS

Chain Bar

IMPORTANT:
 Bars are designed only for the purpose of guiding the chain, and should never be used as crowbars. Turning, twisting, and using the bar as a lever will shorten its service life and void the warranty.

The bar of your chain saw needs as much care as the chain. The running surfaces must be flat and smooth, and the groove must not be expanded. Inspect the groove as shown below:

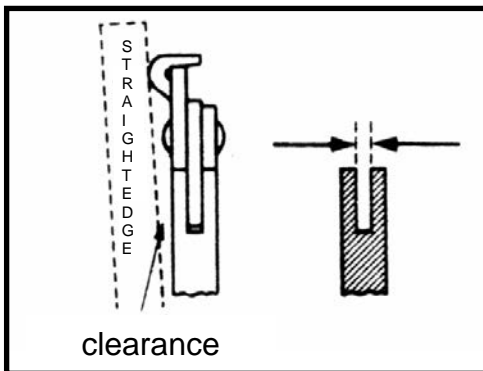



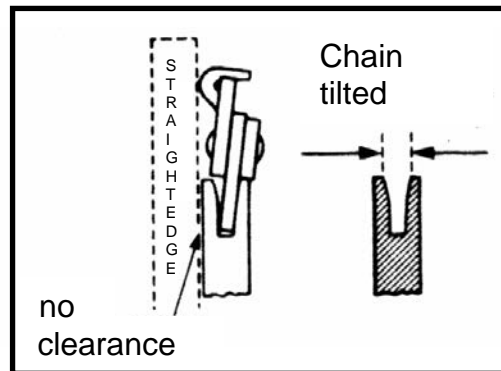

Place straightedge against bar and cutting tooth. If there is clearance between the straightedge and the bar, the bar is OK.

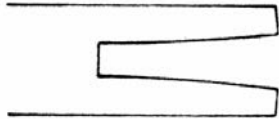
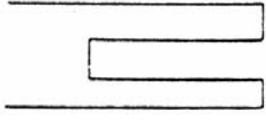

If the chain tilts so that there is no clearance between the bar and the straightedge, the groove is worn.

Replace chain bar!

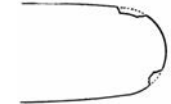
MAINTENANCE AND REPAIRS

Bar Condition	Cause
<p>Worn groove</p> 	<p>Wear due to long service.</p>
<p>Shallow groove, narrow running surface</p> 	<p>Chain tilted. Cutting teeth damaged on one side. Drive link tongues worn.</p>
<p>Blueish areas on running surface</p> 	<p>Groove compressed in the areas. Friction of drive links has caused heating and blue coloration.</p>
<p>Reinforcement chipped</p> 	<p>Bar used improperly. Saw jammed in the cut. Log slid over bar.</p>
<p>Running surface scored</p> 	<p>Improper use caused extreme lateral pressure on the running surface at the bar nose. A common problem most often caused by log slippage.</p>
<p>Cavities in bar</p> 	<p>Impact of the chain behind the reinforced area of the bar as a result of the insufficient chain tension. Dull cutting teeth. Extreme pressure applied to front area of bar.</p>

Sprocket

A damaged sprocket will ruin your chain. Replace a damaged sprocket immediately; the cost is only ¼ that of a new chain. It is therefore uneconomical to run new chains on old sprockets.

Avoid the problems caused by damaged sprocket:

1. Check it each time you mount a new chain, and replace it if it shows signs of wear.
2. Always make sure that the chain tension is sufficient.

MAINTENANCE AND REPAIRS

Maintaining the chain clean and sharpened

Cutting without problems with the right sharpened chain

A saw which was well sharpened pulls itself without problems and light pushing in the wood.

Do not work with a blunt or damaged chain. This leads to a high human exertion, not satisfying result, and a high wear.

Cleaning and checking the chain -

for cracks in the chain links or rivets. Renew damaged and used chain parts and adjust them to the others and correct them.

IMPORTANT!

Keep the following angles and dimensions. A chain with a wrong sharpening especially too low depth limiter can lead to high kickback slope of the saw – **danger of injury**.

Choose sharpening tools which fit to the pitch of the chain –

Allowed pitches of the chain, look „Technical Specification“

The size for the pitch of the chain (e.g. 3/8“) is stamped in the area of the depth limiter of every cutting tooth.

Do only use special chain files!

Other files do not fit in shape and cut

The assignment of the filing diameter does only work after the pitch of the chain. Look table at the bottom of this chapter.

The angles at the cutting tooth have to be kept at the next sharpening.

A = sharpening angle

B = front angle

Type of chain		Angle	
		A	H
Rapid-Micro	(RM)	30	85
Rapid-Super	(RS)	30	60
Picco-Micro	(OM/PMN)	30	85

Mould of teeth:

Micro = Half-chisel tooth
 Super = Chisel tooth

MAINTENANCE AND REPAIRS

The stipulated values for the angles A and B achieve automatically, if you use the stipulated files and filing machines and if there is a right adjusting.

The angles have to be the same to all teeth of the chain. If the angles differ from each other: the running of the chain is rough, uneven, and the wear gets tougher – this can go on to the break of the chain.

Being fulfilled only after enough and intense practicing: **Use a file holder!** *

File super chains by hand only with the aid of the file holder! File holders have got markings for the file angle!

Controlling the angle

Filing gauche * (look list) a versatile tool for the check of sharpening angle and front angle, the height of the depth limiter, length of tooth, depth of the groove and for the cleaning of the groove and oil inlet bores.

The right sharpening

- if using the file holder and FG 1:
- the chain still stays on the guide bar
- if necessary fix the guide bar
- block the chain - hand guard to the front
- for going on pulling back the chain pull the hand guard to the hand pipe
- sharpen often (do not take away much) - for simple resharpening two to three file lines are enough
- file only from the inner side to the outer
- the file only grasps in the forward line - if you move at back lift it up.
- Guide the file:
 - Horizontal** (in a 90° angle to the side surface of the guide bar) corresponding to the mentioned angles - of the markings on the file supports
- Do not file the connecting links and drive links
- Turn the files in regular spaces, to avoid wear on one side only
- Remove file burr with a piece of hard wood
- Check the angle with the file gauge.

All cutting teeth must have the same length

When the length of the teeth is unequal also the height of the teeth is different and that causes a rough running of the chain and cracks in the chain.

File all cutting teeth to the length of the shortest. This can last very long so you better do this in a work shop with an electric sharpening machine.

* Special Accessories

MAINTENANCE AND REPAIRS

The following workings relate to normal operating conditions.

If the conditions get tougher (much dust coming up, very strongly resining wood, tropical wood etc.) and longer work time every day you have to shorten the mentioned intervals.

		before starting work	after work or daily	weekly	monthly	at breakdown	at damage	if necessary
Complete saw	Visual Checking (condition, denseness)	X						
	cleaning		X					
Valve lever, Valve lever latch	Functional gauging	X						
Chain brake	Functional gauging	X	X					
	checking by SPITZNAS Service							X
Lubricating oil tank	checking	X			X			
Chain lubrication	checking	X						
Chain	checking, taking care for sharpness	X	X					
	checking chain tension	X	X					
	sharpening							X
Guide bar	checking (wear, damage)	X						
	cleaning and turning			X		X		
	deburring			X				
	replacing						X	X
Sprocket	checking			X				
Accessible screws and nuts (excepted adjusting screws)	tightening							X
Chain catcher	checking	X						
	replacing						X	

Storing the saw

At operating breaks from about 3 months on

- Take off chain and guide bar, clean them and spray them with protective oil.
- Clean the saw properly
- Fill the lubricating oil tank.
- Store the saw at a dry and safe place.
- Protect it from unauthorized use (e.g. from children).

Procurement of spare parts

When ordering please enter the type description. So you can make it easier to buy a new cutting set.

Guide bar, chain and sprocket are wear parts. So if you buy these parts it is enough to enter part number and the description.

After a repair the warranty claim could only be recognized, if the repairs are done by an authorized SPITZNAS service with original SPITZNAS spare parts.

MAINTENANCE AND REPAIRS

TECHNICAL SPECIFICATION

	Housing material	Length of bar	Length of bar (usable)	Total length	Air consumption	Power	Air connection	ID of hose	Weight
Part No.		mm	mm	mm	m ³ /min	kW		mm	kg
5 1020 0020	Alu	520	430	790	2,9	3	R ¾" female	15 min.	12,8
5 1021 0020	Alu	520	430	790	2,9	3	R ¾" female	15 min.	12,8
5 1022 0020	Alu	520	430	790	2,9	3	R 3" female	15 min.	12,8
5 1023 0020	ZnAl12 (Zamak)	520	430	790	2,9	3	R ¾" female	15 min.	17,3

Chain Saw 5 1020: Available also with usable bar length of 270 mm, 360 mm or 630 mm

Chain Saw 5 1021: with carbide tipped chisel chain and water cooling for cutting plastic

Chain Saw 5 1022: for use underwater

Chain Saw 5 1023: for use in underground mining

Performance data at an operating pressure of 6 bar (flow pressure)

Sound Level (according to ISO / DIS9207)	97.5 dB(A)
Vibration values (according to ISO8662-1 und 8662 - 12)	<2.5 m/s ²
Chain brake effect	< 0.12 sec.
Teeth of the sprocket	8
Free speed of the motor	6500 rpm

ACCESSORIES

	Length	Application	Part No.
Chisel Chain	430 mm	Wood	5 1007 9930
Carbide tipped chisel chain	430 mm	Plastic	5 1005 9950
Chain bar	430 mm	Wood	5 1005 7120
Other chains and bars on request			
Service unit (portable) with pressure regulator ¾"			9 2406 0260
Combi wrench			9 1316 0080
Depth limiter			5 1005 9110
File holder, Assy. with file			9 2550 0030
Manual riveting tool			9 2550 0040
Chain spares for chain 5 1007 9930			5 1007 9910